

# USER MANUAL



Thank you for choosing Better Bathrooms.  
Please read this manual before installing your product  
and keep for future reference.

**better**   
**bathrooms**

## Wall Hung and Pedestal Basin

- Waste, trap and tap sold separately

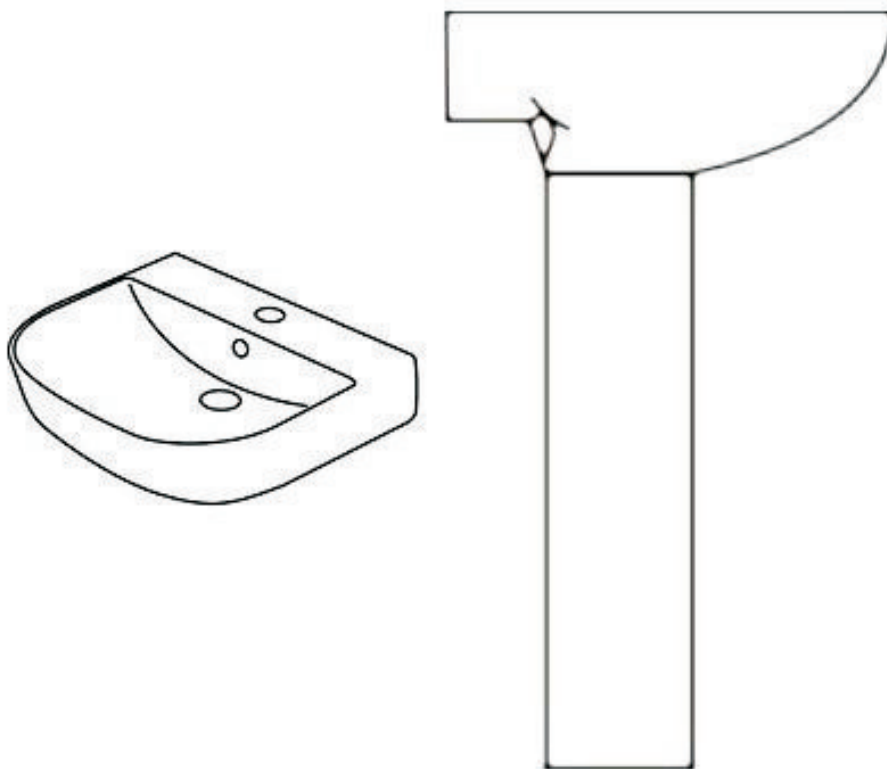

Please note: Image is for illustrative purposes only and may differ slightly to the actual product

- **Multi-person assembly**
- **Tools required**
- **We always recommend using professional tradespeople to install your product**

V2\_8.12.20

# Congratulations on your purchase

*And welcome to our growing gang of savvy shoppers*

We're on a mission to bring you extraordinary bathroom products, for less. From modern to traditional style ceramics, plus the gorgeous fixtures, fittings and furniture to match. So, you can fall in love with your space every single day.

As one of the UK's largest independent bathroom stores, we've received countless awards; including the National Business Awards UK, the Digital Entrepreneur Awards and being placed on The Sunday Times Fast Track 100.

We hope your new product goes above and beyond your expectations. However, should any problems occur, please:

- log in to your account and contact our customer services team via your self-serve portal – [betterbathrooms.com/Account/Login](https://betterbathrooms.com/Account/Login)
- contact us via [betterbathrooms.com/content/contact-us](https://betterbathrooms.com/content/contact-us)

## Important information

- Please read these instructions thoroughly and retain for future reference.
- Manufactured to BS EN14688 Sanitary appliances - wash basins.
- Please ensure that the product is checked for damage prior to installation, any damage reported after installation will not be covered.



## Tools required

Drill, drill bit, spanner, hammer and silicone

# Installation

**IMPORTANT!** Below is the suggested method of installation to a solid wall, if the wall type is different you will require a different fixing type (fixings not supplied)

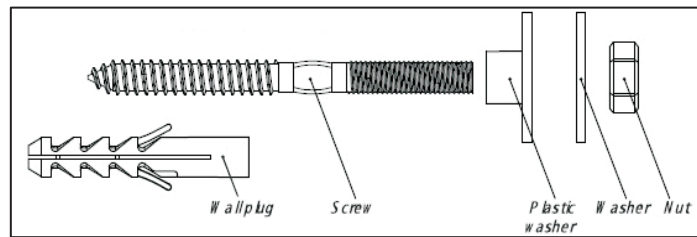

**Please note:** Before commencing any installation check for wires and pipes will not be damaged during drilling

## Installing basin to the wall

1. Offer the basin to the wall, checking that it is level then drill the wall in the required location.

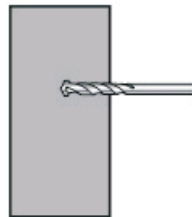

**Please note:** If you are drilling into a tile, it is recommended to tape the wall in the area to be drilled in order to prevent slipping

2. Insert the wall plug into the drilled hole then tap it to the finished wall surface.

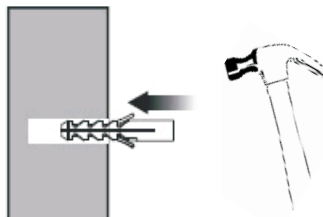

3. Insert the fixing bar and tighten into the wall using a spanner or grips.

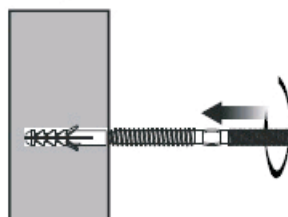

4. Hold the basin over the fixing bar then place the washers over the fixing bar as shown in the installation method diagram at the beginning.

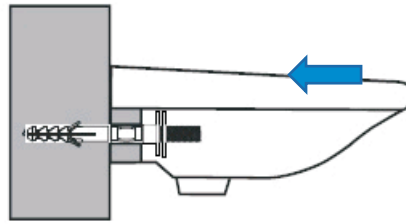

**Please note:** You will require two people for this section of the installation

5. Connect the nut and tighten into position using a spanner, do not overtighten.

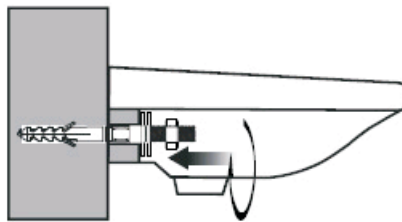

6. Check that the basin is stable then seal along the back edge.

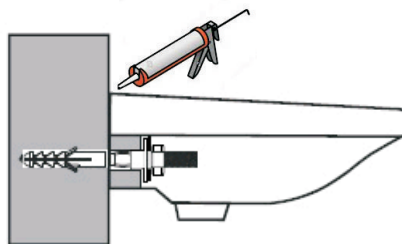

**Please note:** Allow all sealant to dry for at least 24 hours before use



### Installing basin on a pedestal

1. Place the pedestal in the required location then place the basin onto the pedestal and align, so it is level and central. Once aligned, mark the drill holes through the holes in the back of the basin then remove and follow the instructions above from 1-3 (Installing basin to the wall)
2. Relocate the pedestal then the basin, so that the basin slots over the fixing bars then follow the instructions above from 4-6 (Installing basin to the wall).

3. Once the installation is complete, and the basin is secured, seal the basin and pedestal. Seal between the underside of the basin bowl and the top edge of the pedestal. Seal along the front bottom edge of the pedestal.

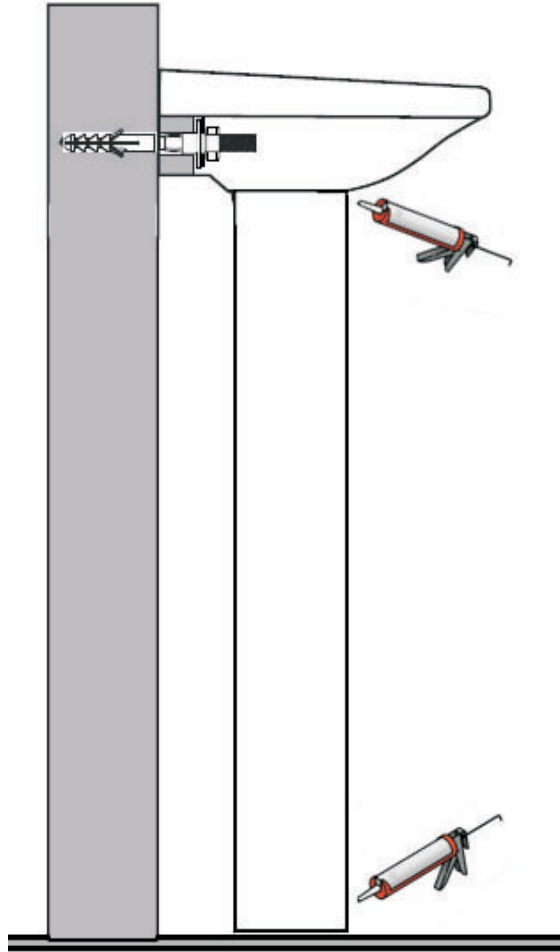

**Please note:** Allow all sealant to dry for at least 24 hours before use



## Cleaning

To maintain the surface finish of your product, wipe clean after every use, using a clean damp cloth, a mild detergent mixture can be used. Do not use abrasive cleaning agents or materials which can strip and scratch the surface; the use of these agents or materials can invalidate your guarantee.

### **For more information**

- visit [betterbathrooms.com](http://betterbathrooms.com)
- email [customerservices@buyitdirect.co.uk](mailto:customerservices@buyitdirect.co.uk)
- call 0330 390 3062
- write to Trident Business Park, Neptune Way, Huddersfield, HD2 1UA

**better  
bathrooms**

Part of the BuyItDirect Group